

EN

**Instructions for Use and
Maintenance**

111680

CE





Thank you for choosing our machine.

The instructions for installation, maintenance and use found on the following pages have been prepared to ensure a long life and perfect operation of your unit.

Please, do follow the instructions carefully.

We have designed and built this machine using the latest innovative technologies. Now you shall take good care of it.

Your full satisfaction is our greatest reward.



READ THESE INSTRUCTIONS CAREFULLY BEFORE INSTALLING THE MACHINE.



WARNING: FAILURE TO COMPLY, EVEN PARTIALLY, WITH THE PRESCRIPTIONS IN THIS MANUAL WILL RENDER THE PRODUCT WARRANTY NULL, AND THE MANUFACTURER SHALL NOT BE LIABLE.

CONTENTS	Page
WARNINGS	33
1. MACHINE DESCRIPTION	35
1.1 Machine Description	35
1.2 Machine features	37
1.3 Data plate	37
2. CONTROL PANEL AND RELATIVE SYMBOLS	38
2.1 Key	38
2.2 Display	38
3. OPERATION	39
3.1 Machine start-up	39
3.1.1 Start-up	39
3.1.2 Start the wash cycle	40
3.1.3 Switching OFF	41
3.2 Cutlery and crockery loading	41
3.3 Detergent use	42
3.4 Rinse aid use	42
3.6 Regeneration function (option)	43
3.7 Extra cold rinse function (option)	44
3.8 Inlet water temperature probe (option)	44
WARNINGS	44
4. ECOLOGICAL ASPECTS	45
4.1 Recommendations for optimal use of energy, water and additives	45
5. H.A.C.C.P. AND HYGIENE REGULATIONS	45
6. MAINTENANCE	46
6.1 Routine maintenance	46
6.2 Extraordinary Maintenance	47
7. MACHINE INSTALLATION	48
7.1 Handling	48
7.1.1 Handling the product	48
7.1.2 Storage	48
7.2 Prepare for installation	48
7.2.1 Room features	48
7.2.2 Electrical connection - Characteristics	48
7.2.3 Water supply connection - Characteristics	49
7.2.4 Water supply characteristics	49
7.2.5 Steam evacuation	49

7.3 Installation	50
7.3.1 Positioning the machine	50
7.3.2 Electrical connection	50
7.3.3 Water connection	50
7.3.4 Start-up	50
8. SIGNALS AND ALARMS	51
8.1 Signals	51
8.2 Alarms	52
9. ENVIRONMENTAL ASPECTS	55
9.1 Packaging	55
9.2 Disposal	55
10. TROUBLESHOOTING	55
11. EU DECLARATION	57



WARNINGS

This instructions booklet must be kept with the machine for future consultations. If the machine is sold or transferred to other users, make sure the booklet always goes with the unit so that the new owner can have all the necessary information on operations and all relevant instructions. The instructions booklet must be carefully read before installation and before starting the machine.

- **Adaptation of the electrical and water systems for dishwasher installation must only be carried out by qualified operators.**
 - The user shall not carry out any repair and/or maintenance operations. In any case contact qualified personnel.
 - Only qualified personnel can access the control panel, when the main power switch is OFF.
 - Servicing of this machine must be performed by authorized personnel only.
 - **N.B.: Use genuine spare parts only. Non-genuine parts will void the warranty and the manufacturer will take no responsibility for any damage.**
 - **Do not use old load pipe, but only new ones.**
 - Follow the instructions given in the manufacturer's booklet for cleaning operations (chap. 6).
 - This machine must only be used by adults. This is a professional machine to be used by qualified personnel, installed and repaired exclusively by qualified Technical Personnel. The Manufacturer declines any responsibility for improper installation, use, maintenance or repair.
 - This appliance can be used by trained youth aged from 15 years and above. It cannot be used by persons with reduced physical, sensory or mental capabilities or lack of experience and knowledge.
 - Children shall not play with the appliance.
 - Cleaning and user maintenance shall not be made by children without supervision.
 - **This machine must be disconnected from the main electrical supply after use at the end of the day and for any service/maintenance operation following this procedure:**
 - Switch the machine off from the control panel.**
 - Drain the tank.**
 - Disconnect the electrical supply by the omni-polar switch (main switch located on the wall).**
 - Shut the water supply valve(s).**
- Disregarding the aforesaid prescriptions is a serious misuse and can cause damages and injures to property and people, and will relieve the manufacturer from whatever liability.**

NOTE: The manufacturer declines any responsibility for accidents to people or any damage deriving from failure to observe the above listed instructions.

1. MACHINE DESCRIPTION

1.1 Machine Description

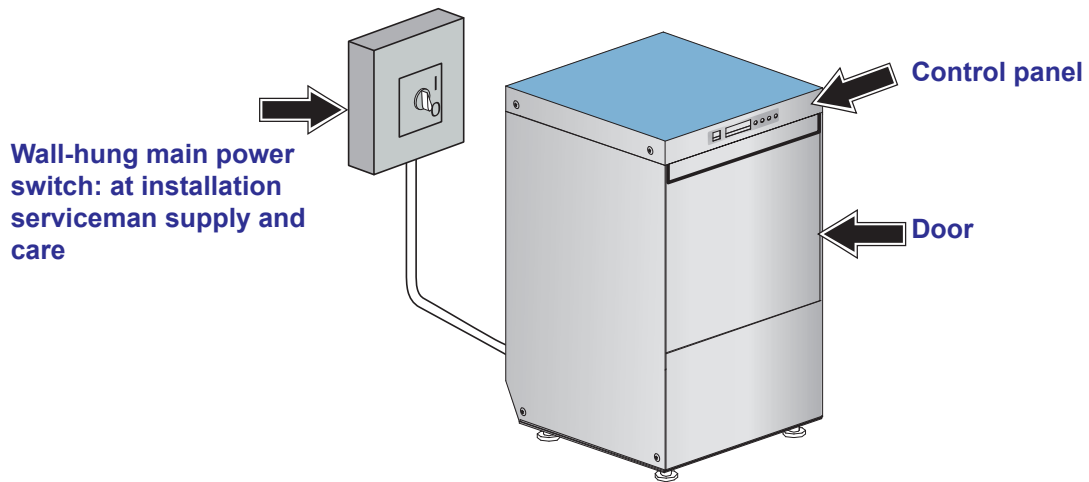

Standard equipment for machine with a 500 mm rack:
nr. 1 glasses rack
and
nr. 1 500x500 mm plates rack
Capacity per plate rack:
12 soup plates or
18 flat plates
Max Ø = 340 mm

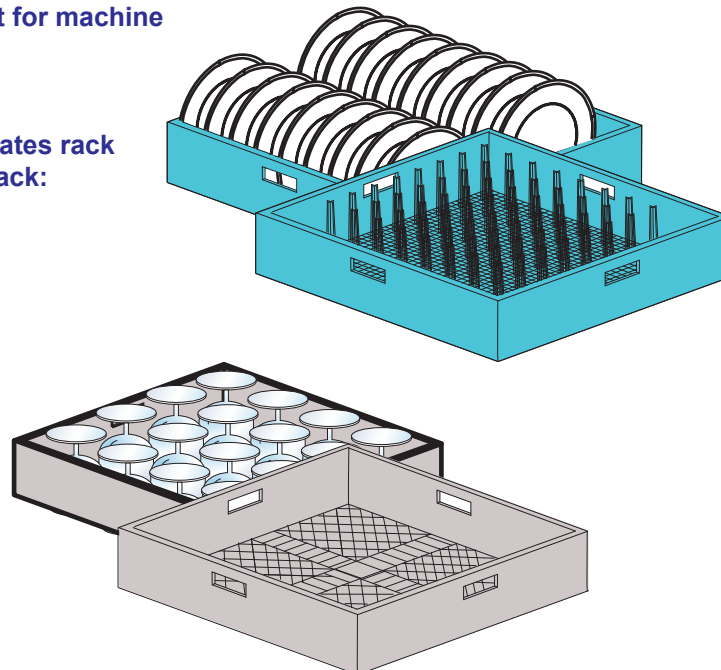

Standard equipment for machine with a 500 mm rack:
nr. 1 cutlery basket

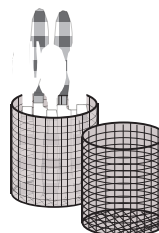

Standard equipment for machine with a 400 mm rack:
 option A) nr. 2 square glasses racks 400x400 mm
 or
 option B) nr. 2 round racks Ø 400 mm
 nr. 1 support for round rack

Option A)

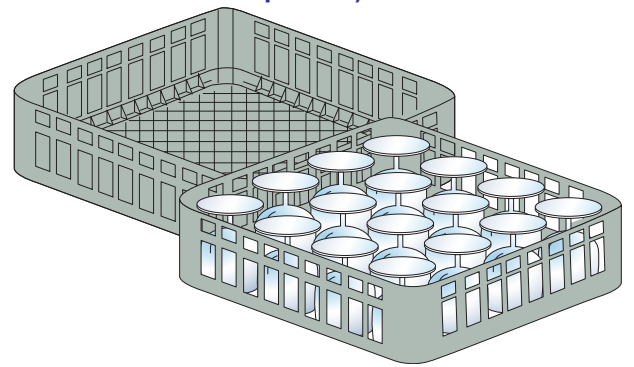

Option B)

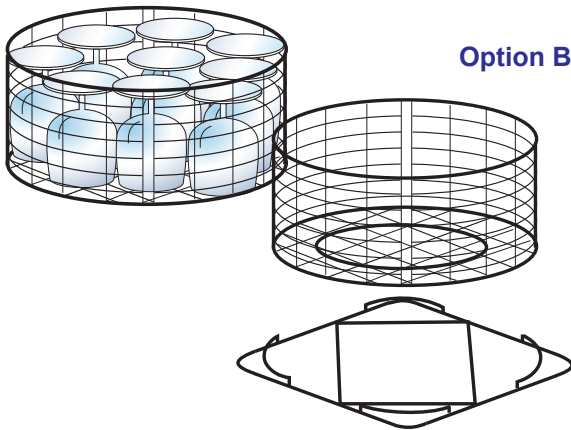

Standard equipment for machine with a 400 mm rack:
 nr. 1 cutlery basket
 and
 nr. 1 saucers holder

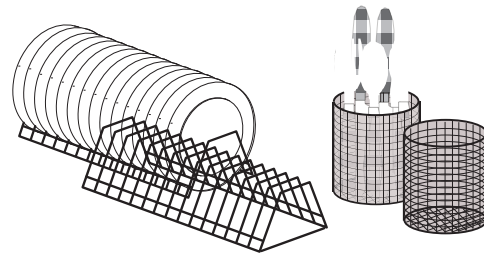

Optional:
 Probe lack
 detergent/rinse aid

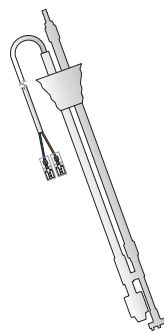

Optional:
 Water softener

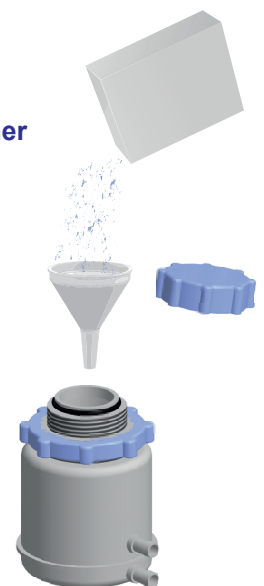

Optional:
 Detergent dispenser

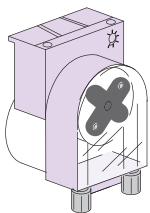

Optional:
 Drain Pump

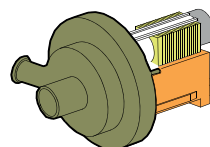
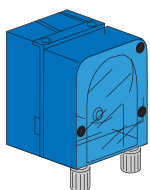
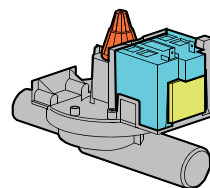

To operate the machine, 3 connections are needed:

- Electrical;
- Water supply;
- Water drain.

This is a cycle machine comprising a wash cycle with detergent and a rinse cycle with injection of rinse-aid.

This machine is designed exclusively for washing dishes, glasses and various pots and pans with human food type of residue.

Any other use is deemed improper.

DO NOT wash articles polluted with petrol, paint, chips of steel or iron, fragile objects or material not resistant to the washing process.

Do not use acidic corrosive chemical products or alkaline and solvents or chlorine based detergents.

Do not open the machine door when operating.

In any case, the machine has a special safety device which immediately stops the unit if the door is open, thus preventing water spillage.

Always switch the machine completely off and drain the water tank, before accessing inside.

The drain pump optional is used to keep the correct water level in the wash tank.

To drain completely the wash tank at the end of the day, see par. **3.5 Drain pump system.**

1.2 Machine features

The machine has a noise level below 65 dB(A).

1.3 Data plate

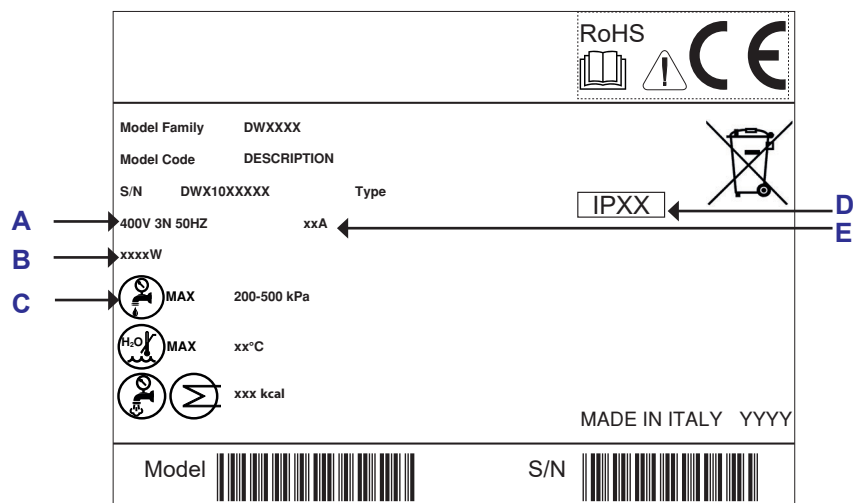

- A** Power source
- B** Total power installed
- C** Dynamic pressure
- D** Envelope protection degree
- E** Total electricity absorption

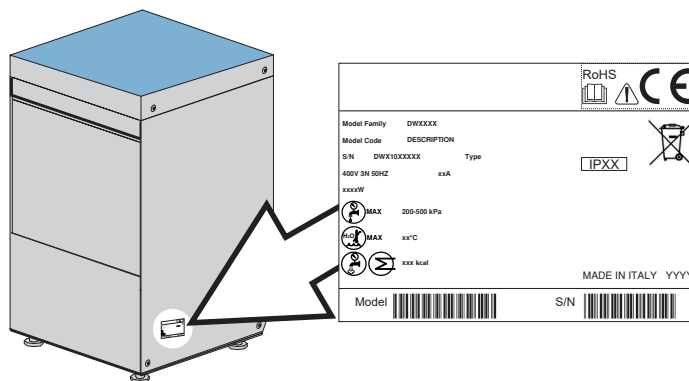
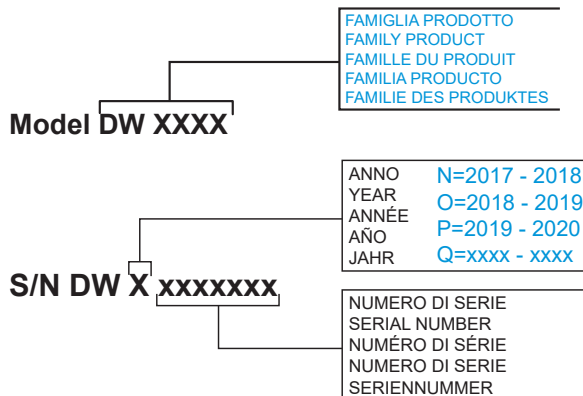

2. CONTROL PANEL AND RELATIVE SYMBOLS

2.1 Key



- A) START key to start up cycle / select cycle
- B) Regeneration key (option)
- C) Extra cold rinse key (option)
- D) Drain key (option)
- E) Switching – On / STAND BY key
- F) Display

2.2 Display

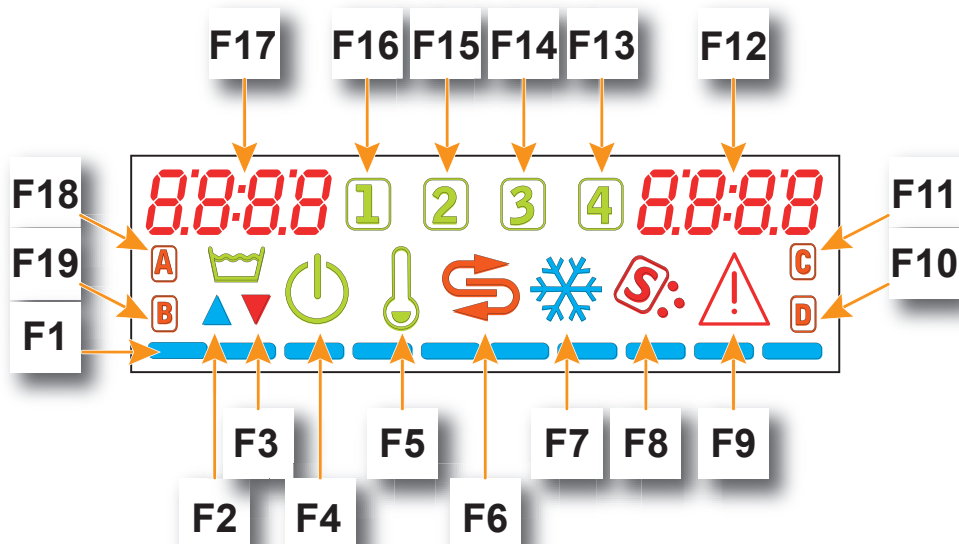

- F1) Totalizer
- F2) Tank filling indicator
- F3) Tank draining indicator
- F4) Stand by indicator
- F5) Heating elements enabled
- F6) Regeneration indicator (option)
- F7) Cold rinse indicator (option)
- F8) Salt shortage indicator (option)
- F9) Alarm indicator
- F10) Detergent level indicator (option)
- F11) Disabled
- F12) Boiler temperature display
- F13) Cycle # 4 running
- F14) Cycle # 3 running
- F15) Cycle # 2 running
- F16) Cycle # 1 running
- F17) Tank temperature indicator
- F18) Self-cleaning cycle running
- F19) Rinse-aid level indicator (option)

3. OPERATION

3.1 Machine start-up

3.1.1 Start-up

• Insert the overflow pipe in the special seat inside the tank. Make sure all the filters are properly fitted in their seats (see pic. 2). The filters must be cleaned every 30-40 wash cycles and whenever necessary.

Do not operate the machine without filters and in particular the pump suction filters.

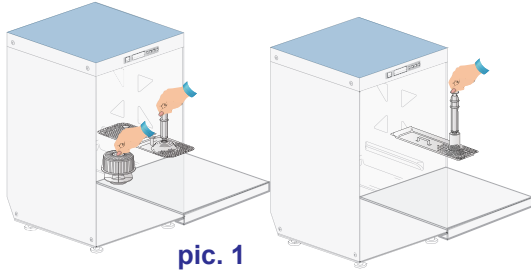

- Close the door.
- Turn the water valve "open".
- Turn the main power switch ON.
- The machine is on **STAND-BY**. In the **G** display are shown: the date (dd/mm on the right) and time (hh/mm on the left).



- Keep pressed the key **E**.
- The machine start will be active when the key **Start A** flashes. After a few seconds the tank filling phase starts. The **F2** indicator and the **F1** temporizer (left to right) light on. Should the machines be equipped with the WRAS certified Break Tank or fed by an osmotic-water device, the tank-filling phase will be longer.



- After filling, the machine automatically starts the heating phase. The phase is displayed by the **Start A** key flashing (green). The tank and boiler indicators **F17** and **F12** switch on. The indicator **F5** switches on.

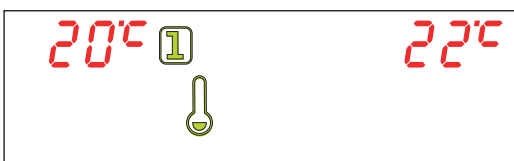

The machine is ready to wash when the set temperatures are reached. The indicator **F5** switches off. The **Start A** key stops flashing.

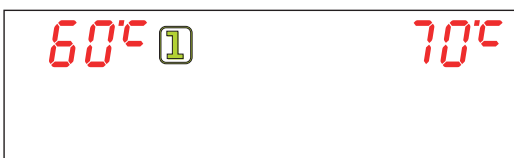

- Insert the special green rinse aid dispenser tube in the liquid rinse aid container and check that the quantity is sufficient for the daily requirement. The transparent tube (if present) must be inserted in the detergent container.

3.1.2 Start the wash cycle

- Insert the rack filled with dishes to wash (see paragraph 3.2). The plates must be correctly placed in the rack.
- Close the door.
- To select the wash cycle (1, 2, 3, 4) keep pressed the key **Start A**. The display will show in sequence the available programs. Once the wanted program is displayed, do release the button.



Available programs:

Cycle Code	Cycle name	Total time (*) (#)	Wash temperature (°C) (#)	Rinse temperature (°C) (#)	
				rack 400	rack 500
1	Cycle 1	60	55	70	70
2	Cycle 2	90	55	70	85
3	Cycle 3	120	55	85	85
4	Cycle 4	180	55	85	85
3+	Cycle 3 HYGIENE+	180	70	---	90
4+	Cycle 4 HYGIENE+	620	70	---	90

(*): Timing calculated without the intervention of the Thermostop device.

(#): The cycles (1, 2, 3, 4) are a customizable cycles according to the user's needs, to be set by a technician during the machine installation, **HYGIENE+** version excluded cycles (3+, 4+).

(+): These cycles are available on the **HYGIENE+ - rack 500** version only, upon request.

The indicator **F5** switches on.

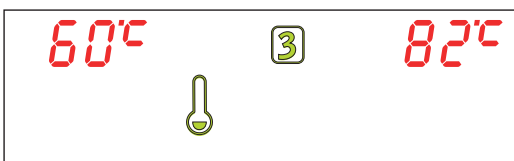

Start the cycle by pressing the key **Start A** (for 1 second maximum). The key **Start A** turns blue on (steady light). The **F1** totalizer displays the time progression from the cycle start.

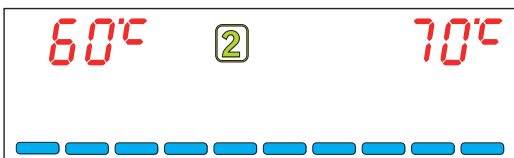

If during the selected cycle the boiler temperature (indicator **F12**) drops below the set value, the machine keeps washing until the set temperature is reached (Thermostop).

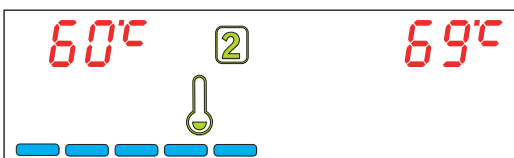

- At the end of the cycle the key **Start A** alternatively flashes in blue/green. The display shows the message **END** and the **F1** totalizer is completed.

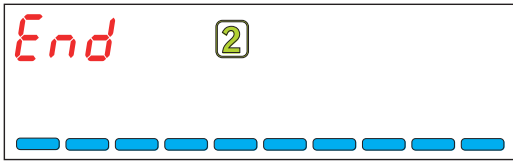

- The machine is ready for a new wash.

Note: It is advisable to change the tank water, by means of another filling, at least every 30 washes or twice a day. An alarm flashes when this operation is needed (see **Warning**).

Note: The machine does not accept other cycles until the door is opened or the key **Start A** is pressed for two seconds.

3.1.3 Switching OFF

- Keep pressed the key **E**. The machine will turn in stand by-mode (**F4** steady red indicator).
- Drain the wash-tank. Take off the overflow pipe. For machines equipped with drain pump see par. **3.5**.
- At the end of the day, clean the machine (see chap. **6 Maintenance**).
- Shut the water valve.
- Switch the main power switch OFF.



3.2 Cutlery and crockery loading

Before cutlery and crockery loading in the machine, coarsely clean them from the leftover food.

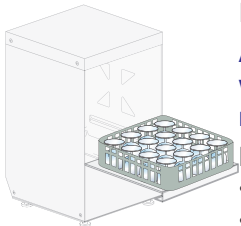

It isn't necessary to rinse the cutlery and crockery under water.

ATTENTION: Do not wash articles polluted with petrol, paint, chips of steel or iron, ash, sand, wax, lubricant grease. These substances damage the machine. Do not wash fragile objects or material not resistant to the washing process.

Note the following recommendations:

- Crockery and cutlery should not be inserted inside one another, covering each other.
- Place the crockery in order to all surfaces can be reached by water; otherwise the dishes are not washed.
- Make sure all the crockery are in a stable position and that the hollow containers don't overturn (cups, glasses, bowls, etc.) .
- Place in the rack all the hollow containers such as cups, glass, etc. **upside-down**.
- Place the crockery with deep hollow with upper face downwards, so that water can flow out.
- Make sure the smaller crockery do not fall from the rack.
- Check all the wash arms runs freely and they are not blocked by too tall or too prominent crockery.

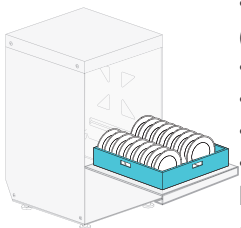

Eventually, run a manual rotation of the arms to check it.

Some foods, such as carrots, tomatoes, and others, may contain some natural dyes substances, that in large amounts, can alter the crockery and plastic parts colors.

Any discoloration does not mean that the plastic is not heat resistant.

Crockery and cutlery not suitable for dishwasher

Not suitable for dishwasher:

- Wooden crockery and cutlery or with wooden parts; water at high temperature causes deformation to wood. Also the adhesives used are not suitable for treatment in the dishwasher; a consequence could be the handles detachment.
- Crafts, precious vases or decorated glasses.
- Not heat-resistant plastic crockery.
- Copper, brass, pewter or aluminum objects: they may become discolored or opaque.
- The decorations on glass, after a certain number of washes, can lose gloss.
- Fragile glasses or crystal items, if often washed, can become opaque.

We recommend to buy exclusively crockery and cutlery suitable for dishwashing.

After several washes, the glass can become opaque.

It is mandatory to repeat the washing cycle if at the end of the cycle the crockery are not well clean or if there are washing residues (glasses, cups, bowls, etc. with liquid inside).

3.3 Detergent use

By request the dishwasher can be equipped with an electric detergent dispenser (always recommended). The machine automatically sucks the detergent.

The detergent shall be the NO FOAM type, suitable for industrial dishwashers. The use of good quality liquid detergents is recommended.

Follow the manufacturer's recommendations for chemical dosage, related to the local water hardness.

A correct amount of detergent is very important for a successful wash.

Should the detergent lack the **F10** indicator on the display flashes (only with optional "Sensor for Chemicals Low Level").

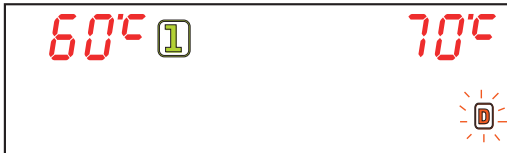

3.4 Rinse aid use

The machine has a standard rinse aid dispenser. The machine automatically sucks the product.

The rinse-aid chemical, shall be suitable for professional glass and dishwashers. It is advisable to rely on specialized retailers in the sector.

Should the rinse-aid chemical lack the **F19** indicator on the display flashes (only with optional "Sensor for Chemicals Low Level").

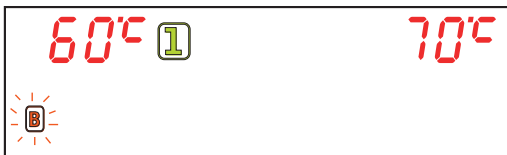

3.5 Drain pump system (option)

The cycle drain pump works in an automatic and independent way.

At the end of the day, to completely empty the tank:

Remove the overflow.

Close the door. Press the KEY **D**; the tank draining indicator **F3** and the totalizer turn on for the time set by the program.

After the draining is complete, the machine turns automatically in **STAND-BY** mode.

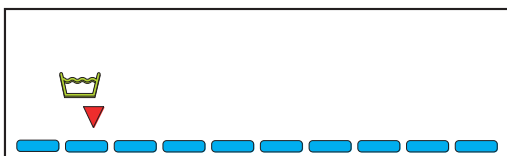

This operation is also possible with machine in stand by-mode. Once finished, the machine returns to the initial mode.

See chap. 8 if an alarm appears.

Note: The machine must not be switched ON during the emptying phase.

IMPORTANT: Always turn the main wall switch off and close the water valve at the end of use.

3.6 Regeneration function (option)

Should the machine be equipped with a water-softener circuit, this will be fully automatic.

When needed, a 120" regeneration cycle will automatically activate (machine ON). During this phase the indicator **F6** switches on (steady).

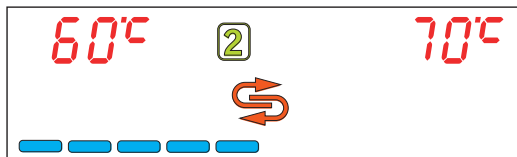

If needed the cycle can be activated even during the wash-tank loading. **If the activation is made during the wash-cycle, this will be longer.**

The circuit board is designed to call periodically for a 20 min. manual regeneration cycle (according with the water hardness adjusted). This regeneration cycle can also be activated by the user, should the rinse quality be dissatisfactory. The indicator **F6** flashes.

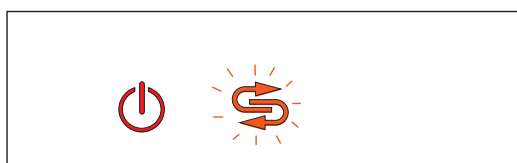

IMPORTANT: Before starting a regeneration cycle check if there is salt in the special container.

When the indicator **F8** flashes on the display it means that the salt level in the bowl is low (only on machines equipped with the optional Water Softener).



To add salt, open the machine door and unscrew the salt container plug inside the tank.

Fill the special container with specific coarse salt for regeneration (coarse salt: 0,500kg - 1-4 mm grains), being careful not to spill it into the tank. A strong concentration of salt can negatively affect the correct functioning and service life of the machine and generate rust and the steel corrosion. After filling with salt, lock the plug tightly.

To start a complete regeneration cycle it is needed to switch off the machine with the key **E**.

The indicator **F4** turns on.

Drain the tank. Remove the overflow. For machines equipped with drain pump see par. **3.5**.

Press the key **B**. The indicator **F6** turns on. The machine carries out with the various phases.

The cycle is finished when the indicator **F6** goes off after around 20 minutes.

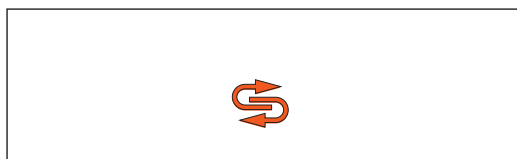

The machine returns to stand by-mode (indicator **F4** lighted).

Note: Regeneration times will be blocked only if the door is opened.

The optional regeneration is not allowed in the following conditions:

- During programming.
- During the wash cycle.
- During manual draining.
- If the tank is filled; in this case the message **drAln tAnk** will be displayed for about 4sec.
- If the machine is ON.



In the case of water hardness above 35°f it is advisable to install an external water softener

3.7 Extra cold rinse function (option)

This function can only be enabled if the machine is equipped with the optional **Cold rinse** function.

Machine ON. Press the key **C**.

After the normal rinse cycle an extra cold rinse is made for few seconds with tap water.

During the wash cycle or manual draining the type of rinse selected cannot be changed.

The Extra cold rinse function selection is displayed by the **F7** indicator lighting.

Note: The Additional Cooling selection is not memorized. It must be set every time the machine is switched off and then on again (if this function is required).



3.8 Inlet water temperature probe (option)

The machine can be equipped with a built-in inlet water probe that allows verifying the boiler inlet water-temperature.

With machine in ready-mode, by pressing both the key **A** and **C** it is possible to visualize the temperature.



WARNINGS:

- Do not slam the door when opening and closing.
- Do not put material or objects on the machine.
- The machine has an IP (see serial number label on the machine) protection rating against accidental water splashes and is not protected against pressurized water jets. Pressure-cleaning systems shall, therefore, not be used on this machine.
- Do not dip bare hands into water containing detergent. If this should occur, wash them immediately with plenty of water. Check the safety instructions on the detergent container.
- Some important rules must be followed for using this appliance:
 - 1) never touch the appliance with wet hands or feet;
 - 2) never use the appliance when barefooted;
 - 3) do not install the appliance in places exposed to water splashes.
- **This machine must be disconnected from the main electrical supply after use at the end of the day and for any service/maintenance operation. Switch off the main switch located on the wall, which shall be installed by a professional installer. Shut the water supply valve(s).**
- Do not cover the intake or dissipation grids.
- Do not use water to extinguish fires on electrical parts.

WARNING: INTERNAL CLEANING OF THE MACHINE SHALL BE CARRIED OUT AT LEAST 10 MINUTES AFTER THE POWER SWITCH HAS BEEN TURNED OFF.

WARNING: DO NOT INSERT HANDS AND/OR TOUCH THE PARTS LOCATED AT THE BOTTOM OF THE WASH TANK AND/OR AT THE END OF THE WASH CYCLE.



4. ECOLOGICAL ASPECTS

4.1 Recommendations for optimal use of energy, water and additives

Salt dosing: A pre-set (by the manufacturer) quantity of salt is injected in the resins at each regeneration cycle. It is important to observe the number of regeneration cycles recommended in paragraph **3.6 Regeneration device** in order to avoid salt spills or lime deposits.

Use the machine fully loaded when possible: This shall prevent detergent, rinse aid, water and energy consumption waste.

Detergent and rinse-aids: Use detergents and rinse-aid chemicals with high biodegradability, to best respect the environment. Verify proper dosage in relation to water hardness at least three times a year. Excess product pollutes rivers and seas while an insufficient dose results in unsatisfactory dish washing and/or hygiene.

Boiler and Wash-Tank temperatures: The boiler and tank temperatures are set by the manufacturer in order to obtain the best washing results with detergents on the market. The temperatures can be reset by the installer in relation to your detergent.

Pre-washing: Carefully pre-wash with a moderate amount of water at room temperature to facilitate the removal of animal fats. To remove encrusted materials warm water soaking is recommended.

Note: Wash objects as soon as possible to avoid deposits from drying and compromise effective washing.

For effective washing routine dishwasher cleaning and maintenance is advised (see chap. **6**).

Disregarding the points listed above and of any the information contained in this manual can cause energy, water and detergent waste with a subsequent increase in running costs and/or performance reduction.

5. H.A.C.C.P. AND HYGIENE REGULATIONS

- When starting the machine ON, no wash-cycle will be starting until the set boiler and wash-tank temperatures are reached. During operation, the machine will not start the rinse cycle till the set boiler temperature is reached.
- Remove carefully all solids from the objects to be washed, to avoid obstruction of filters, nozzles and piping.
- Drain the wash tank and clean the filters at least twice a day.
- Check if the detergent and rinse-aid dosage are correct (as recommended by the manufacturer). In the morning, before starting the machine, check that the quantity of chemicals in the canisters is enough for daily supply.
- Keep your working tables clean.
- Extract the rack with clean hands or gloves to avoid finger marks.
- Do not dry or polish the washed objects with cloths, brushes or rags that are not sterile.

6. MAINTENANCE

6.1 Routine maintenance



WARNING: The machine is not protected against pressurized water jets. Do not use pressure cleaning system against the machine.

It is recommended to contact seller for cleaning instructions, in order to have detailed indications on methods and products for the correct periodical machine sanitation.

Do not use bleach or chlorine based detergents.

Daily cleaning is needed to ensure that the machine runs perfectly. The following shall be carried out:

- Turn the machine in stand-by mode, by pressing the key **E** (see chap. 2).
- Remove the surface filters and clean them under running water. Drain the tank water (see par. 3.1.3).
- Remove the pump filter and clean with a brush and a water shower (see pic. 5).
- Remove the arms by loosening the fixing screws, and thoroughly clean them, and the nozzles under running water (see pic. 5).
- Reassemble the parts and reposition the wash pipes firmly in place. Take extreme care to re-assemble the nozzles in the right position (open and / or closed nozzles) and that the arms are installed with the right axial angle.

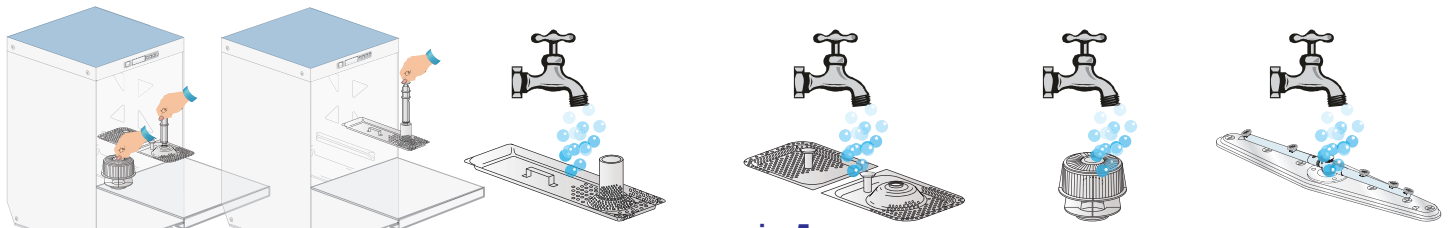

pic. 5

- Clean the tank very carefully, using a water shower.
- It is recommended to leave the machine door open at the end of the day.
- Shut the water valve.
- Turned off the machine by switching the main power switch OFF.

Automatic cycle of machine self-cleaning/rinsing: recommended at each day end.

The machine should be in stand by-mode (without filter, without overflow pipe and machine door closed). Press the key **Start A**; an automatic cycle of 1 minute will start, after this the machine will be stand by-mode.

- Shut the water valve.
- Turned off the machine by switching the main power switch OFF.

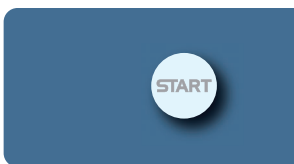



6.2 Extraordinary Maintenance

Once or twice per year, the machine should be checked by **qualified Service Personnel**:

- 1 Clean the intake filter of the solenoid valve.
- 2 Remove scaling from the heating elements.
- 3 Check the status and the tightness of all gaskets.
- 4 Check the perfect state and/or wear of the components. If a component is damaged or oxidized replace it immediately, with genuine spare parts only.
- 5 Check the efficiency of the dispensers.
- 6 Check the efficiency of the door safety switch.
- 7 Tighten firmly all electrical connections (qualified Service Personnel only).

Every 3-4 years of machine use, double-check the tightening and the efficiency of all electrical contacts, with special attention to the contacts of starters and relays. Increase controls frequency if the machine is operating in heavy or intensive conditions.

7. MACHINE INSTALLATION

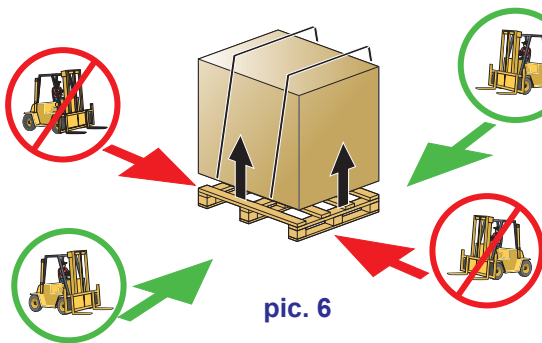

7.1 Handling

7.1.1 Handling the product

The machines must be handled strictly as shown in pic. 6 regarding the grip points indicated for lifting with a lift truck.

Latch the machine in a way that secures no vibration or shocks during transportation.

Note: Slings with ropes not recommended.

After unpacking, make sure the appliance has not been damaged due to transportation. If it has been, do notify the seller about this problem. If the damage might question the machine's safety, do not install the appliance.

Double check the firm tightness of all hose-clamps on piping, nuts and bolts, and fasteners, that might come loose with the transport, to prevent water dripping or leakages, or other damages, during the machine's operation.

See chapter **9 ENVIRONMENTAL ASPECTS** for disposal of the packing material.

7.1.2 Storage

Storage temperature: min. +4°C - max +50°C - humidity <90%.

The stored parts should be checked periodically, to detect any sign of deterioration.

Do not put anything on the machine, even if packed in its box.

7.2 Prepare for installation

This is just a guide-line for the machine installation.

The installation must be performed by a qualified engineer.

7.2.1 Room features

Install the machine, in a room closed to weather and with a guaranteed temperature-range between 5 and 35°C.

The machine is equipped with thermostatic sensors to manage the temperatures. To guarantee a proper functionality these sensors shall not operate at a room temperature below 5°C.

For this reason, it is fundamental that before starting the machine reaches the room temperature.

7.2.2 Electrical connection - Characteristics

The electrical connection to network shall be carried out in accordance to the local laws in force.

Make sure that the supply voltage is the same as reported on the machine plate and that the network can stand the needed power absorption shown on the same plate.



A suitable omni-polar one-way switch shall be installed and sized according to the absorption provided, in order to completely guarantee the disconnection from the supply mains, under "category III" overvoltage conditions.

This switch shall be included in the power network solely and exclusively used for this purpose and installed in the immediate vicinity of the machine.

Always turn the machine off via this switch. This is the only model of switch that guarantees a total electrical power disconnection.

Make sure that the facility is equipped with efficient ground connection.



WARNING: check very carefully if the "ground connection" of the machine, is properly sized and fully efficient, and that not too many units are connected on it. An undersized or poor "ground connection" might lead to corrosion and/or pitting effect on the stainless steel plates, even to perforation.

7.2.3 Water supply connection - Characteristics

Fresh water supply features:

Table 1

Water characteristics table	Min	Max
Static Pressure	200kPa	400kPa
Dynamic Pressure*	150kPa	350kPa
Water hardness**	2°f	8°f
Cold water-supply temperature***	5°C	50°C
Hot water-supply temperature****	50°C	60°C
Capacity	10l/min	

Connect the machine's water supply with an interrupt valve capable of quickly and completely shutting off water intake.

***It is compulsory to install a water-softener, in case of water with average hardness above 8°f.** Washed objects will be cleaner and the machine will last much longer.

The machine can be equipped with a water softener, on request. If the machine is equipped with a water-softener, a regeneration of the resins shall be done on regular basis (see par. **3.6 Regeneration device**).

N.B.: Any damage caused by limestone (calcareous water higher-up than 8°f and without water-softener) will not be covered by warranty.

A periodical check of the supplied water hardness is highly recommended.

**Machines shall be made with extra power in case of cold water infeed.

***The water supply temperature shall never exceed 55°C.

7.2.4 Water supply characteristics

The machine water supply must be potable, in compliance with Directive 98/83/EC.

The inlet water must also meet the parameters given in the table 2.

Table 2

Water parameters table	Min	Max
Chlorine ¹		2mg/l
pH	6,5 ¹	8,5 ³
Water hardness		8°f ²⁻³
Iron ³		0,2 mg/l
Manganese ⁴		0,05 mg/l

¹ Out of range values might lead to corrosion and jeopardize the life of the machine.

² Should the water hardness is higher **it is compulsory** to install a water softener and check periodically its operation.

³ Out of range values might lead scaling and sediments with a consequent lower performance, functionality, and expected life of the machine.

⁴ Desired value: Out of range values might lead stainless steel blackening/tarnishing.

It is recommended a water test once a year.

7.2.5 Steam evacuation

In accordance with regulations of environmental hygiene, for the proper functioning of the machine and a healthy environment for the operator who working in there, it should be at least 10 air volume changes per hour in the room where the machine is installed.

For small wash rooms we recommend at least 15 air volume changes per hour.

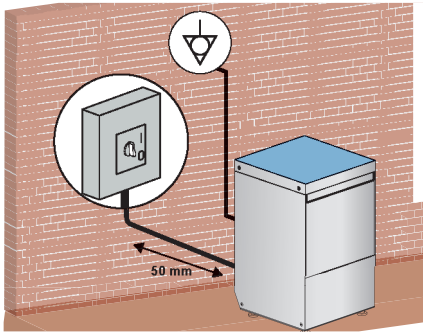

pic. 7

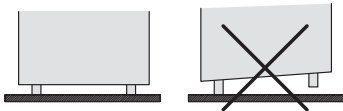

pic. 8

7.3 Installation

7.3.1 Positioning the machine

Remove the packing with care.

Lift the machine as described in par. 7.1.1 **Handling the product**.

Position the machine as shown on the installation diagram (lay-out) approved at the time of the offer.

Maintain a minimum distance of about 50 mm from the walls, so that motors are ventilated (see pic. 7). Install suction hoods to assure proper ventilation of the room, in order to eliminate steam and excessive humidity.

Check that the machine is properly levelled, by adjusting the legs (see pic. 8).

Make sure the machine is not standing on the power cable or on the filling/drain hoses. Level the machine flat, by adjusting the support feet.

7.3.2 Electrical connection

The electrical connection shall be carried out in accordance to the local laws in force.

The machine has a connection at the back, indicated by the symbol , that is meant to link the steel structure and masses among different apparatuses, to prevent electro-static electrical shocks.

The electrical supply cable must be new, flexible, and according to "har" H07RN-F or a local valid equivalent. The cable size is dimensioned according to the power.

If the machine is fitted with a three-phase pump, check the correct motor rotation (right rotation as per arrow on the casing). This is not needed if the pump is a single-phase model (standard).

7.3.3 Water connection

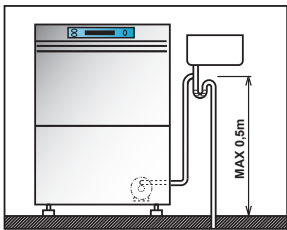

pic. 9

Connect the water in-feed hose, given with the machine, to a $\frac{3}{4}$ " water supply tap.

Connect the machine draining pipe to the connection located at rear, under the back-panel, in such a way that water flows freely (therefore ensuring a minimum slope). If the water cannot be discharged to a level below the machine drain, it is advisable to install a drain pump (supplied on request).

Maximum drain height = cm. 50 (see pic. 9).

The drain tube shall always be connected to a siphon in order to prevent the release of odors.

In those machines equipped with "water softener" the water supply temperature shall not exceed 40°C, to avoid damages to the filters' resins.

7.3.4 Start-up

At installation engineer's care.



8. SIGNALS AND ALARMS

8.1 Signals

The signals messages are visualized, based upon their meaning.

Machine in stand-by mode:

Total regeneration warning (option). When the **F6** indicator flashes on the display it means that a total regeneration is needed (only on machines equipped with the optional Water Softener).



Drain tank warning. When **drain tank** scrolling message appears on the display it means that you are trying an operation that cannot be done with the wash tank full.

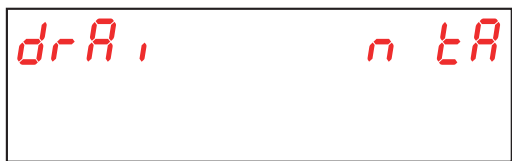

Machine switched on or in stand-by mode:

Door open warning. When **door** appears on the display it means that you are trying an operation that cannot be done with the open door.



Machine switched on:

Draining tank warning. When the **F3** indicator flashes on the display it means that it is necessary to change the tank water.

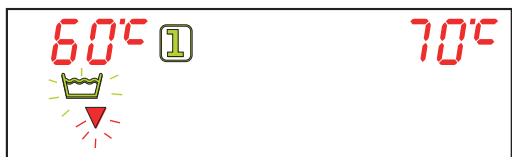

Salt level warning (option). When the **F8** indicator flashes on the display it means that the salt level in the bowl is low (only on machines equipped with the optional Water Softener).

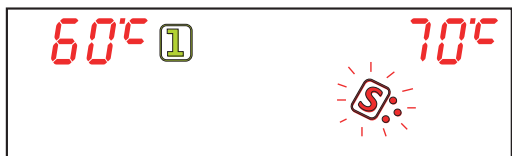

Detergent level warning (option). When the **F10** indicator flashes on the display it means that the detergent is over (only on machines equipped with the optional "Chemicals level Sensor").

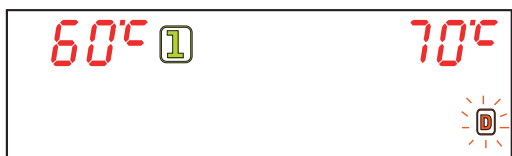

Rinse-aid level warning (option). When the **F19** indicator flashes on the display it means that the rinse-aid is over (only on machines equipped with the optional "Chemicals level Sensor").



Flowmeter failure warning (option). When the **F9** symbol appears on the display it means that no passage of water is detected and the inlet water temperature probe is damage or is disconnected (only on machines equipped with the optional "Flowmeter" installed and enabled, after the water filling or the rinse). By pressing both the key **A** and **C** for about 10 seconds the message **Err FLuS** appears.

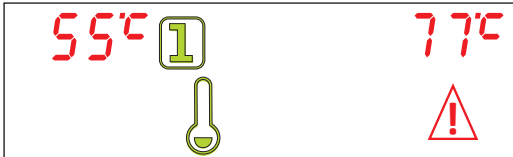

Water probe failure (option). By pressing both the key **A** and **C** for about 3 seconds it is possible to check the machine inlet water temperature (only on machines equipped with the optional "Loading water probe" installed and enabled). If the water probe is damage or disconnected the message **FAIL 000°C** appears.



8.2 Alarms

The alarms are displayed, based upon their meaning.

If an alarm occurs the machine stops.

TYPE OF ALARM	CAUSE
B2	BOILER PROBE FAILED
B3	BOILER HEATING ALARM
B4	FAILURE RINSING
B5	BOILER OVERHEATING
B9	BOILER SAFETY THERMOSTAT
E1	WATER LOAD FAILED
E2	TANK PROBE FAILED
E3	TANK HEATING ALARM
E5	TANK OVERHEATING
E6	TANK DRAINING FAILED
E8	TANK SAFETY THERMOSTAT
Z6	TANK LOW LEVEL
Z9	REGENERATION FAILED

ALr

b2

**B2. BOILER PROBE FAILED:**

Cause: The circuit board does not detect the boiler sensor.
Remedies: Contact Technical Service.

ALr

b3

**B3. BOILER HEATING ALARM:**

Cause: The factory-set boiler temperature was not achieved in the maximum foreseen time limit.
Remedies: Contact Technical Service.

ALr

b4

**B4. FAILURE IN RINSING (on machines equipped with the BREAK TANK):**

Cause: The Break Tank water was not used during the rinse cycle.
Remedies: Contact Technical Service.

ALr

b5

**B5. BOILER OVERHEATING:**

Cause: The water temperature in the boiler exceeded 105°C.
Remedies: Contact Technical Service.

ALr

b9

**B9. BOILER SAFETY THERMOSTAT**

Cause: The boiler safety thermostat is tripped.
Remedies: Contact Technical Service.

ALr

E1

**E1. WATER LOAD FAILED:**

Cause: The machine wash-tank was not filled in the maximum foreseen time limit.
Remedies: Open the water supply valve and verify a proper water supply flow.
Contact Technical Service.

ALr

E2

**E2. TANK PROBE FAILED:**

Cause: The circuit board does not detect the wash-tank sensor.
Remedies: Contact Technical Service.

ALr

E3

**E3. TANK HEATING ALARM:**

Cause: The factory-set wash-tank temperature was not achieved in the maximum foreseen time limit.
Remedies: Contact Technical Service.

ALr

E5

**E5. TANK OVERHEATING:**

Cause: The wash-tank temperature exceeded 90°C.
Remedies: Contact Technical Service.

**E6. TANK DRAINING FAILED:**

Cause: The draining of the wash-tank was not completed within the maximum foreseen time limit.

Remedies: Contact Technical Service.

**E8. TANK SAFETY THERMOSTAT**

Cause: The tank safety thermostat is tripped.

Remedies: Contact Technical Service.

**Z6. TANK LOW LEVEL:**

Cause: The tank pressure-switch detects a too low level of water in the tank.

Remedies: Check the overflow pipe. Contact Technical Service.

**Z9 REGENERATION FAILED (on machines equipped with the optional Water Softener):**

Cause: The salt sensor does not work properly.

Remedies: Check if there is salt in the special container. Contact Technical Service.

9. ENVIRONMENTAL ASPECTS

9.1 Packaging



Packaging is made of the following components:

- a wooden pallet;
- a nylon sack (LDPE);
- a multi-layer carton;
- polystyrene (PS) strips;
- polypropylene (PP) banding.

All above materials, shall be disposed and treated in accordance with the Local Laws in force.

9.2 Disposal



The symbol WEEE/RAEE used on this product indicates that it cannot be treated as domestic waste. Proper disposal of this product contributes to protecting the environment. For more information on product recycling, contact the local authorities, domestic waste authorities or the dealer where the product was purchased.

For product or parts disposal, follow the Council directives 2011/65/UE and 2012/19/UE as amended and/or application legislative decrees.

The present product or parts cannot be disposed of as urban waste but shall be collected in separate containers (see the waste bin on wheels symbol with an "X" on the product).

At the time of product disposal, the user shall refer to the waste electrical and electronic equipment (WEEE/RAEE) specification. The manufacturer guarantees the absence of dangerous substances in the EEA used in conformity to the directive 2011/65/UE. If the user does not comply with the regulations he/she shall be subject to the penalties foreseen by each member state.

Disconnect electricity and water before disposal.

Cut away the electrical cable to ensure that further use is impossible.

All metal parts are recyclable as they are made of stainless steel.

Recyclable plastic parts are marked with the plastic material symbol.

10. TROUBLESHOOTING



Type of Problem	Possible Causes	Cure
The machine does not turn on	Main switch not ON.	Turn switch ON.
The machine does not load water.	Water valve shut.	Open the water valve.
	Rinse nozzles or solenoid-valve filter blocked and/or scaled with limestone.	Clean the rinse arm nozzles, piping and solenoid-valve filter. If the machine is equipped with a water softener check the salt content or regenerate the resins more often
	Defective pressure-switch.	Replace pressure-switch.
The machine loads water very slowly	Scarce water supply pressure	Check the water supply pressure
	Rinse booster pump blocked (if installed)	Contact Technical Service.
Washing results are unsatisfactory.	The washing nozzles are obstructed or the rack does not rotate.	Remove the wash rack and clean the wash nozzles. Check the right positioning of the wash-arm, tightening firmly.
	Foam is present	Use no-foam detergents or reduce the dose in use.
	Fats or starches not removed.	Insufficient detergent concentration.
	Filters are dirty.	Remove filters, clean with brush under a jet of water and replace in original position.
	Check tank temperature (which must be between 55°C and 60°C).	Contact Technical Service.
	Wash time insufficient for the type of dirt.	Select a longer wash-cycle, if possible, otherwise repeat the wash cycle.
	Wash water is dirty.	Drain the tank water, clean the filters; refill the tank and replace the filters correctly.

Type of Problem	Possible Causes	Cure
Objects are not properly dried	Not enough rinse aid.	Increase dosage. Contact Technical Service.
	The rack is not suitable for the objects	Use the suitable rack which gives the objects an inclined position so that water can rinse away.
	The washed items may have been sitting in the wash chamber too long.	As soon as the cycle stops, remove the rack with objects so that they can dry more quickly in the air.
	Rinse water temperature too low	Check the boiler temperature.
	Surface of dishes and glasses too rough or porous for material wear.	Replace type of dishes and glasses used.
Streaks and spots on objects.	Too much rinse-aid chemical.	Reduce the rinse aid amount. Contact Technical Service
	Too hard water.	Check the water quality. Water must not exceed 2-8°f in hardness.
	For appliances with softener: too little salt in the salt container or the resins have not been properly regenerated.	Fill the salt container (coarse salt: 1-4 mm grains) and regenerate the resins more often. If lime deposits are also observed on the body of the machine, have a qualified technician check the operation of the water softener.
	Salt present in dishwasher sump.	Thoroughly clean and rinse the appliance, and avoid spilling salt when filling the container.
The machine suddenly stops during operation.	The machine is connected to an overload device.	Contact Technical Service
	A machine safety device was triggered.	Check the electrical devices (Contact Technical Service).
The washing pump doesn't work	The pump is blocked	Contact Technical Service.

**N.B.: For any other question, please contact your Service provider.
The manufacturer has right to modify any technical characteristics without prior notice.**

11. EU DECLARATION

The machine purchased is in compliance with the norms stated in the EU declaration attached to the machine in original. Please find attached below the facsimile of this declaration, with the general data of the machine purchased. For the absorption data refer to the data-plate on the machine.

DICHIARAZIONE DI CONFORMITA' UE
EU DECLARATION OF CONFORMITY
DÉCLARATION EU DE CONFORMITÉ
EU-KONFORMITÄTSEKTLÄRUNG
DECLARACIÓN EU DE CONFORMIDAD
DECLARAÇÃO EU DE CONFORMIDADE



Il sottoscritto (1), autorizzato dall'azienda (2), dichiara che la lavastoviglie elettrica per uso collettivo (3) è stata progettata e costruita in conformità alle norme armonizzate (4) secondo quanto prescritto dalle seguenti direttive e successivi emendamenti (5) e in applicazione a quanto previsto dalle direttive citate, è stata dotata di Marcatura CE e sono stati predisposti i fascicoli tecnici presso la nostra sede (2). Tale dichiarazione riguarda esclusivamente la macchina nello stato in cui è stata immessa sul mercato, escludendo i componenti aggiunti e/o le operazioni effettuate successivamente dall'utente finale. Declina ogni responsabilità per sinistri a persone, a cose o ad animali derivanti da manomissione della macchina da parte di terzi, ovvero da carenze di manutenzione, di riparazione o di installazione della stessa da parte di personale non qualificato. (*)

The undersigned (1), authorized by the company(2), hereby declares that the commercial electric dishwashing machine (3) is in compliance with the harmonised standards (4) according to the following directives and further amendments (5) and pursuant of the above mentioned directives, the CE Marking have been applied. Furthermore, adequate technical files have been prepared and are available at our offices (2). This declaration relates exclusively to the machinery in the state in which it was placed on the market, and excludes components which are added and/or operations carried out subsequently by the final user. Declines all responsibility for damages to people, properties and animals resulting from bad servicing of the machine by third parties as from inadequate maintenance or repairs or installation by unskilled technicians.

Le soussigné (1), désigné par la société (2), déclare que le lave-vaisselle électrique à usage collectif (3) est conforme aux normes harmonisées (4) selon les prescriptions et directives suivantes et les amendements successifs (5) et en application des directives citées, il porte le Marquage CE. Les dossiers techniques sont déposés dans notre siège (2). Cette déclaration concerne exclusivement la machine dans l'état dans lequel elle a été mise sur le marché et exclut les composants ajoutés et/ou les opérations effectuées par la suite par l'utilisateur final. Décline toute responsabilité pour tout sinistre à personnes, choses ou animaux résultant de l'endommagement de la machine par un tiers, c'est-à-dire dû à une maintenance, des réparations ou une installation inadéquates effectuées par du personnel non-qualifié.

Der Unterzeichnete (1) berechtigt von der Firma (2), erklärt, daß die elektrischen Spülmaschinen für den gewerblichen Gebrauch (3). In Übereinstimmung mit den harmonisierten Normen ist (4) gemäß folgender Richtlinien und deren nachfolgenden Änderungen (5) und daß in Übereinstimmung mit den erwähnten Richtlinien die CE-Kennzeichnung angebracht wurde und daß die relevanten technischen Unterlagen zusammengestellt wurden (2). Diese Erklärung bezieht sich nur auf die Maschine in dem Zustand, in dem sie in Verkehr gebracht wurde; vom Endnutzer nachträglich angebrachte Teile und/oder nachträglich vorgenommene Eingriffe bleiben unberücksichtigt. Jede Verantwortung für an Personen, Sachen und Tieren verursachten Schäden, die durch die Manipulation seitens Dritten, beziehungsweise auf mangelhafte Wartung und Reparaturarbeiten oder Installation von unqualifiziertem Personal zurückzuführen sind, werden abgelehnt.

Quien subscribe (1), elegido de la empresa (2), declara que el lavavajilla eléctrico de uso colectivo (3) es conforme a las normas armonizadas (4) como la prescripción de la siguientes directivas y sucesivas enmiendas (5) y, conforme con lo previsto en las citadas directivas, han recibido el Marcado CE. Existe asimismo los específico expediente técnico relativo disponible en nuestro domicilio (2). Esta declaración se refiere únicamente a las máquinas en el estado en que se comercialicen, con exclusión de los elementos añadidos y/o de las operaciones que realice posteriormente el usuario final. Declina toda responsabilidad por daños a personas, cosas o animales producidos del mal servicio de la máquina por terceras partes así como por reparaciones o mantenimiento inadecuados o de instalaciones por parte del personal no cualificado.

O abaixo-assinado (1), autorizado pela empresa (2), vem por este meio declarar que a máquina de lavar louça para uso comercial (3) esta de acordo com as normasharmonizadas (4) de acordo com o previsto pelas seguintes diretivas e posteriores alterações (5) a Marcação CE foi aplicada no seguimento das diretivas mencionadas. Os processos técnicos estão preparados e adequados e encontram-se disponíveis na nossa sede (2). Esta declaração diz respeito apenas à máquina tal como se encontra no momento da colocação no mercado, excluindo-se os componentes adicionados e/ou as operações efectuadas posteriormente pelo utilizador final. Declina toda e qualquer responsabilidade por danos causados a pessoas, bens e animais, resultantes do mau manuseamento da máquina por parte de terceiros assim como manutenção incorrecta ou reparações inadequadas ou instalação por pessoal não qualificado.

(*) **Lingua originale / Original language / Originalsprache / Langue originale / Idioma original / Idioma original**

2)	3)
4) EN 60335-1:2012; EN 60335-2-58:2005; EN 55011:2009; EN55014:2006; EN 61000 3-2:2006; EN 61000 3-3:2008; EN61000 3-11:2000; EN 61000 3-12:2005; EN 61000 4-2:2009; EN61000 4-4:2010; EN 61000 4-5:2006; EN 61000 4-6:2009; EN61000 4-11:2004	5) 2014/30/EU; 2006/42/EC; 2011/65/EU; 2012/19/EU
1) Preposto/Person in Charge	Firmato in originale e conservato presso la nostra sede (2). Original document signed and available at our office (2). Dieses Dokument ist im Original unterzeichnet und bei uns aufbewahrt (2). Signé en original et gardé à notre siège (2). Firmado en original y conservado en nuestro domicilio (2). Original assinado e armazenado na nossa sede (2).