

100100

NL - België	Gebruiksaanwijzing en installatievoorschriften	p. 2
FR - Belgique France	Mode d'emploi et d'installation	p. 5
DE - Belgien Deutschland Österreich Schweiz	Montage- und Bedienungsanleitung	p. 8
EN	Operating and installation Instructions	p. 11
NL - Nederland	Gebruiksaanwijzing en installatievoorschriften	p. 14

706/1 - 736/1 - 739/1 - 749/1 - 750/1
906/1 - 936/1 - 939/1 - 949/1 - 950/1

NOVY®

GENERAL INFORMATION

- Please read these operating instructions carefully. They contain information about installation, operation, safety and maintenance you need to be aware of.
- This hood is for domestic use only
- It is recommended to have the installation done by a qualified professional. Any damage due to faulty or unprofessional installation relieves the manufacturer of any form of responsibility.
- Check the condition of the hood and the installation material before installing. Carefully remove the hood out of the packaging. Be careful not to use sharp knives to open the box.
- Please keep these instructions to pass on to future users.
- Disposal of transport packaging and old appliance
Your new appliance was sent to you in protective packaging. All utilised materials are environmentally safe and recyclable. Please help us by disposing of the packaging in an environmentally friendly manner.

Old appliances are not worthless rubbish. Valuable raw materials can be reclaimed by recycling old appliances. This appliance is identified according to the European Directive 2002/96/EC on waste electrical and electronic equipment. Please ask your dealer or inquire at your local authority about current means of disposal.

- Technical problem
In case of technical problems please contact Novy Service Department:
For Belgium: Tel.: 056/36.51.02
For France: Tel.: 03.20.94.06.62
For Germany: Tel.: 0511.54.20.771
For all other countries: your local installor or Novy Belgium: +32 (0)56/36.51.02
Please supply us with the model number of your hood. The model number can be found on the engraved plaque behind the filter.
You can make a note of the number here:
- For all remarks or questions to which this manual doesn't answer please contact our Customer Service:
For Belgium: Tel.: 056/36.51.01
For France: Tel.: 03.20.94.06.62
For Germany: Tel.: 0511.54.20.771
For all other countrys: your local installor or Novy Belgium: +32 (0)56/36.51.02

Use

NOTE: These operating instructions apply to several appliance models. It is possible that individual features are described which do not apply to your appliance.

When using a hood sufficient air flow is necessary. However large your kitchen may be, there is only so much air available in that space. Opening a door or window or the installation a ventilation grid close to the hood insures a good quality of air flow.

Insufficient air flow will impair the extraction efficiency of your hood immensely.

Insufficient air flow can cause reflux from other air ducts such as chimneys or combustion appliances.

When using a cooker hood and appliances using energy other than electrical in the same space, the pressure in the room may not surpass 4 Pa (= 0.04mBar).

Safety

- Deep frying under the hood is only allowed under constant supervision.
- Under no circumstances is it allowed to flambé under the hood.
- In case of fire always switch off the hood.
- Never extinguish burning fat or oil with water. Cover the pot with a well fitting lid or a burn-blanket.

Advice

For maximum efficiency please follow this advice:

- When cooking make sure pots are positioned properly under the hood surface.
- Activate the hood a few minutes prior to cooking.
- Switch the hood off 10 minutes after cooking is finished (switch off with 10 minute delay).
- Avoid drafts under the hood surface.
- When using induction: adapt the intensity of both hob and hood to the lowest possible level in order to avoid excessive creation of damp fumes.

Operation

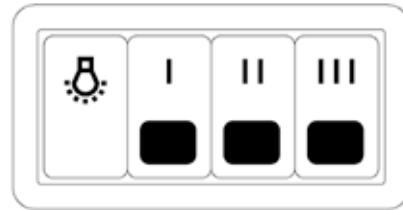

- III High extraction
- II Medium extraction
- I Slow extraction
-  Lighting

Installation

These hoods are equipped with a powerful centrifugal fan and the NOVY Silencer. Cooking fumes and vapours are evacuated through a filter to the exterior. Radial extraction covers the entire cooking surface thus guaranteeing a high level of efficiency. These appliances are for domestic use only. They can be installed in a deep cupboard, chimneybreast, island, etc.

Minimum installation height: 60 cm above electric, 65 cm above gas and 75 cm above induction cookers.

Maximum installation height: 80 cm above cooking surface.

Please check if all installation materials are enclosed in the packaging.

Maintenance

Maintenance of the grease filter

The hood contains one or two metal filters which should be cleaned twice a month.

Access to the filter

Take hold of the right and left side of the plate (a) and pull down simultaneously.

Remove the filter (b) by taking hold of its hook and pulling down.

Cleaning the filter:

- in the dishwasher
- manually: in a hot solution of water and a liquid detergent. Rinse and allow to dry completely

Important! The previous instructions need to be followed. If not an increased fire hazard may occur.

Maintenance of the hood

Please allow the lights to cool down sufficiently before cleaning the hood.

Use a soft, wet cloth and a mild detergent to clean the hood.

Never use aggressive, abrasive detergents or sponges. Bleach will damage stainless steel.

The stainless steel surfaces can be treated with Novy Innoxcleaner (906.060) after cleaning.

Replacing the lamps

Please allow the lights to cool down sufficiently before touching them. Cover and protect delicate surfaces underneath the hood when changing lamps.

If the TL-lamp needs replacing you can take out the glass plate at the front by unscrewing the two screws at the back of the glass plate.

For the hoods of 60 cm the TL-lamp is 15 Watt, for the hoods of 90 and 100 cm it is 18 Watt.

Electrical connection

Electrical output: electrical cord + plug with ground. To be plugged into socket with ground. Check for compatibility with information on type plate (behind filter).

Socket must be within reach.

Changes or replacement of the electrical cord should be performed by a professional only.

Dimensions: p. 19

Electrical scheme: p. 20

Afmetingen - Dimensions - Abmessungen - Dimensions

706-736

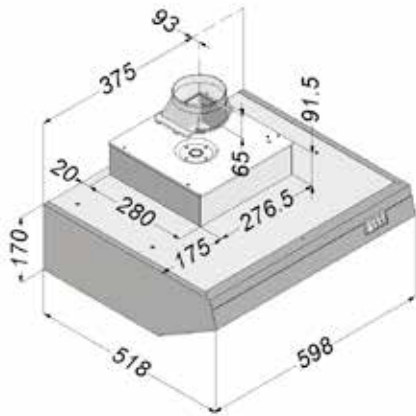

739

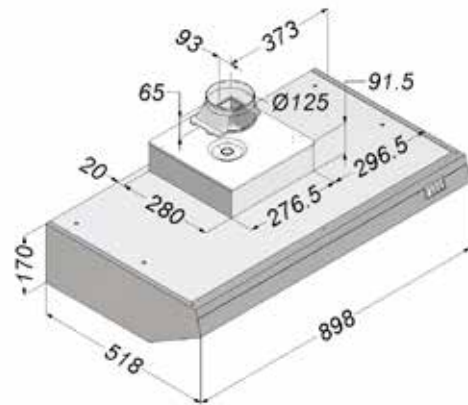

749

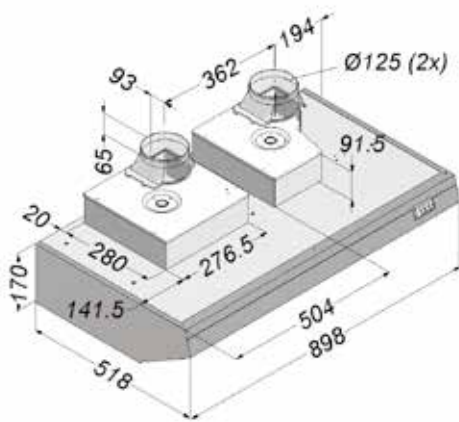

750

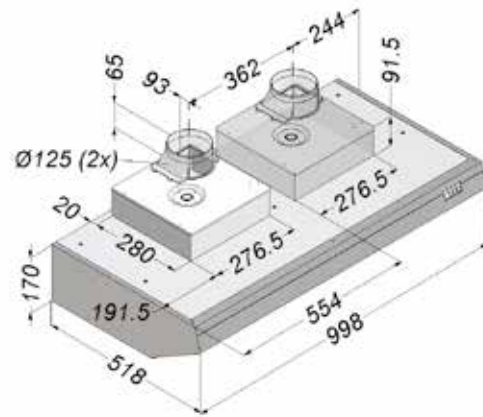

936

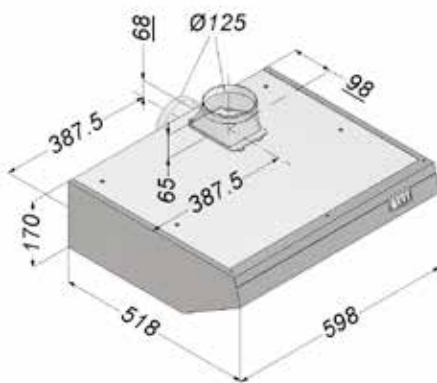

939

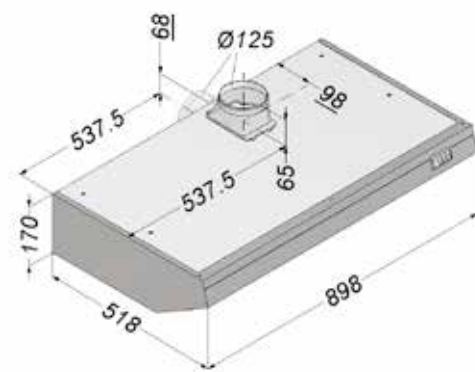

949

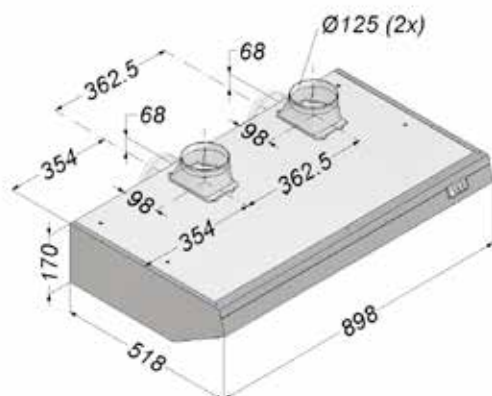

950

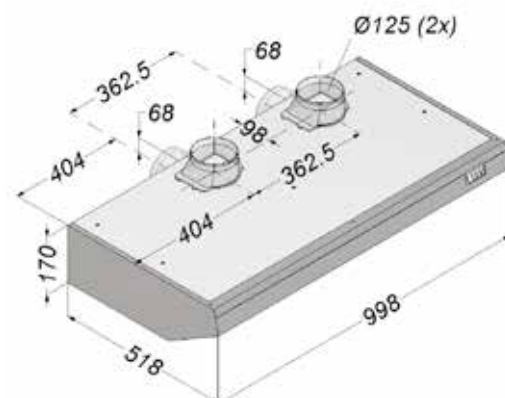

Elektrisch schema - Schéma électrique - Elektrischer Schaltplan - Electrical scheme

706 - 736 - 739 - 906 - 936 - 939

749 - 750 - 949 - 950

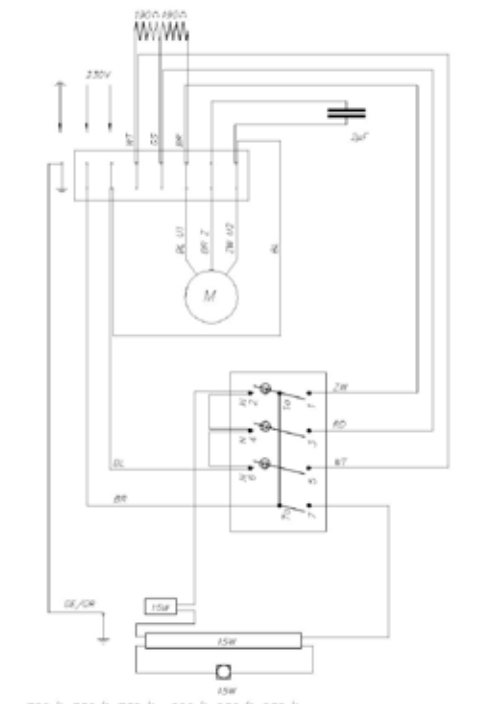

706/1 736/1 739/1 906/1 936/1 939/1

WT	wit	blanc	weiss	white
GE/GN	geel/groen	jaune/vert	gelb/grün	yellow/green
GS	grijs	gris	grau	grey
RD	rood	rouge	rot	red
BL	blauw	bleu	blau	blue
BR	bruin	brun	braun	brown
ZW	zwart	noir	schwarz	black

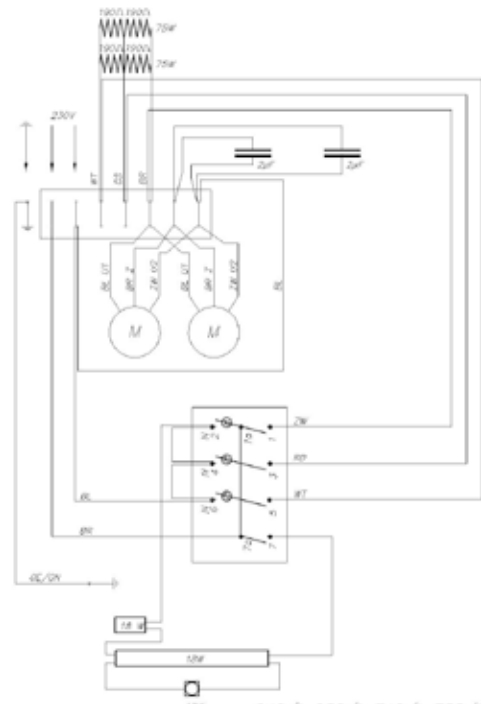

949/1 950/1 749/1 750/1

WT	wit	blanc	weiss	white
GE/GN	geel/groen	jaune/vert	gelb/grün	yellow/green
GS	grijs	gris	grau	grey
RD	rood	rouge	rot	red
BL	blauw	bleu	blau	blue
BR	bruin	brun	braun	brown
ZW	zwart	noir	schwarz	black